

## PV Based Active Type SFCL For Reducing Fault Current And Over Voltages Distribution System

K Navya \*, Dr. M Prameela \*\*

\*1 PG Scholar, Department of E.E.E,  
B. V. Raju Institute of Technology, Narsapur,  
Medak(Dist), Telangana, India

\*\*2 Professor, Department of E.E.E,  
B. V. Raju Institute of Technology, Narsapur,  
Medak(Dist), Telangana, India

May 21, 2018

### Abstract

Now a days Faults are occurring commonly in the power systems. Superconducting fault current limiter is an eye-catching electronic device to solve the problematic of very high fault current in the power system. In this paper, the performance of enriched system capacity with existing switchgear by superconducting fault current limiter is studied. At first, a resistive type SFCL is modeled in Simulink. The active SFCL is composed of an air-core superconducting transformer and a PWM converter. The magnetic field in the air-core can be controlled by adjusting the converters output current, and then the active SFCLs equivalent impedance can be regulated for current limitation and possible overvoltage suppression. In this paper a novel PV based SFCLs is designed and simulated in MATLAB. The simulation results show that the active PV based SFCL can play

an palpable role in restraining the fault current and over-voltage, and it can contribute to avoiding damages in the power system

***Index Terms:*** PV, superconducting fault current limiter (SFCL), DG, Fault.

## 1 INTRODUCTION

Due to increased consumption demand and high cost of natural gas and oil, distributed generation (DG), which generates electricity from many small energy sources, is becoming one of main components in distribution systems to feed electrical loads [1][3]. The introduction of DG into a distribution network may bring lots of advantages, such as emergency backup and peak shaving. However, the presence of these sources will lead the distribution network to lose its radial nature, and the fault current level will increase. Besides, when a single-phase grounded fault happens in a distribution system with isolated neutral, overvoltages will be induced on the other two health phases, and in consideration of the installation of multiple DG units, the impacts of the induced overvoltages on the distribution networks insulation stability and operation safety should be taken into account seriously. Aiming at the mentioned technical problems, applying superconducting fault current limiter (SFCL) may be a feasible solution.

For the application of some type of SFCL into a distribution network with DG units, a few works have been carried out, and their research scopes mainly focus on current-limitation and improvement of protection coordination of protective devices [4][6]. Nevertheless, with regard to using a SFCL for suppressing the induced overvoltage, the study about it is relatively less. In view of that the introduction of a SFCL can impact the coefficient of grounding, which is a significant contributor to control the induced overvoltages amplitude, the change of the coefficient may bring positive effects on restraining overvoltage.

We have proposed voltage compensation type active SFCL in previous work [7], and analyzed the active SFCLs control strategy and its influence on relay protection [8, 9]. In addition, a 800 V/30 A laboratory prototype was made, and its working performances were confirmed well [10]. In this paper, taking the active SFCL as

an evaluation object, its effects on the fault current and overvoltage in a distribution network with multiple DG units are studied. In view of the changes in the locations of the DG units connected into the distribution system, the DG units injection capacities and the fault positions, the current-limiting and overvoltage-suppressing characteristics of the active SFCL are investigated in detail.

## 2 THEORETICAL ANALYSIS

### A. Structure and Principle of the Active SFCL:

As shown in Fig. 1(a), it denotes the circuit structure of the single-phase voltage compensation type active SFCL, which is composed of an air-core superconducting transformer and a voltage-type PWM converter.  $L_{s1}$ ,  $L_{s2}$  are the self-inductance of two superconducting windings, and  $M_s$  is the mutual inductance.  $Z_1$  is the circuit impedance and  $Z_2$  is the load impedance.  $L_d$  and  $C_d$  are used for filtering high order harmonics caused by the converter. Since the voltage-type converters capability of controlling power exchange is implemented by regulating the voltage of AC side, the converter can be thought as a controlled voltage source  $U_p$ . By neglecting the losses of the transformer, the active SFCLs equivalent circuit is shown in Fig. 1(b).

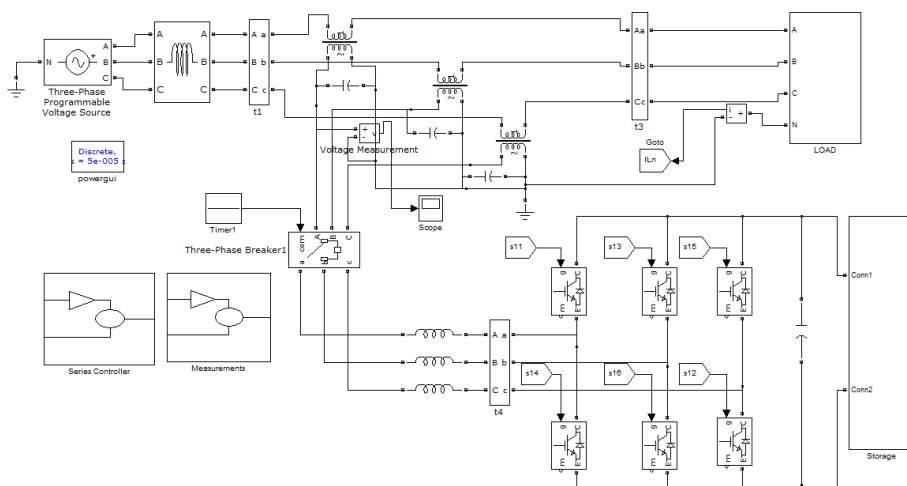

Fig. 1. Three-phase voltage compensation type active SFCL

In normal (no fault) state, the injected current ( $I_2$ ) in the secondary winding of the transformer will be controlled to keep a certain value, where the magnetic field in the air-core can be compensated to zero, so the active SFCL will have no influence on the main circuit. When the fault is detected, the injected current will be timely adjusted in amplitude or phase angle, so as to control the superconducting transformers primary voltage which is in series with the main circuit, and further the fault current can be suppressed to some extent.

Below, the suggested SFCLs specific regulating mode is explained. In normal state, the two equations can be achieved.

$$\dot{U}_s = \dot{I}_1(Z_1 + Z_2) + j\omega L_{s1}\dot{I}_1 - j\omega M_s\dot{I}_2 \quad (1)$$

$$\dot{U}_p = j\omega M_s\dot{I}_1 - j\omega L_{s2}\dot{I}_2 \quad (2)$$

Controlling  $I_2$  to make  $j\omega L_{s1}\dot{I}_1 - j\omega M_s\dot{I}_2 = 0$  and the primary voltage  $U_1$  will be regulated to zero. Thereby, the

$$\dot{I}_{1f} = \frac{(\dot{U}_s + j\omega M_s\dot{I}_2)}{(Z_1 + j\omega L_{s1})} \quad (3)$$

$$\begin{aligned} \dot{U}_{1f} &= j\omega L_{s1}\dot{I}_{1f} - j\omega M_s\dot{I}_2 \\ &= \frac{\dot{U}_s(j\omega L_{s1}) - \dot{I}_2 Z_1(j\omega M_s)}{Z_1 + j\omega L_{s1}} \end{aligned} \quad (4)$$

equivalent limiting impedance  $Z_{SFCL}$  is zero ( $Z_{SFCL} = U_1/I_1$ ), and  $I_2$  can be set as  $\dot{I}_2 = \dot{U}_s L_{s1}/L_{s2}/(Z_1 + Z_2)k$ , where  $k$  is the coupling coefficient and it can be shown as  $k = M_s/\sqrt{L_{s1}L_{s2}}$ . Under fault condition ( $Z_2$  is shorted), the main current will rise from  $I_1$  to  $I_{1f}$ , and the primary voltage will increase to  $U_{1f}$ .

The current-limiting impedance ZSFCL can be controlled in:

$$Z_{SFCL} = \frac{\dot{U}_{1f}}{\dot{I}_{1f}} = j\omega L_{s1} - \frac{j\omega M_s\dot{I}_2(Z_1 + j\omega L_{s1})}{\dot{U}_s + j\omega M_s\dot{I}_2} \quad (5)$$

According to the difference in the regulating objectives of  $I_2$ , there are three operation modes:

- 1) Making  $I_2$  remain the original state, and the limiting impedance  $Z_{SFCL1} = Z_2(j\omega L_{s1}) / (Z_1 + Z_2 + j\omega L_{s1})$ .
- 2) Controlling  $I_2$  to zero, and  $Z_{SFCL2} = j\omega L_{s1}$ .
- 3) Regulating the phase angle of  $I_2$  to make the angle difference between  $\dot{U}_s$  and  $j\omega M_s \dot{I}_2$  be  $180^\circ$ . By setting  $j\omega M_s \dot{I}_2 = c\dot{U}_s$ , and  $Z_{SFCL3} = cZ_1 / (1-c) + j\omega L_{s1} / (1-c)$ .

The air-core superconducting transformer has many merits, such as absence of iron losses and magnetic saturation, and it has more possibility of reduction in size, weight and harmonic than the conventional iron-core superconducting transformer [11], [12]. Compared to the iron-core, the air-core can be more suitable for functioning as a shunt reactor because of the large magnetizing current [13], and it can also be applied in an inductive pulsed power supply to decrease energy loss for larger pulsed current and higher energy transfer efficiency [14], [15]. There is no existence of transformer saturation in the air-core, and using it can ensure the linearity of  $Z_{SFCL}$  well.

#### B. Applying the SFCL Into a Distribution Network With DG

As shown in Fig. 2, it indicates the application of the active SFCL in a distribution network with multiple DG units, and the buses B-E are the DG units probable installation locations.

When a single-phase grounded fault occurs in the feeder line 1 (phase A, k1 point), the SFCLs mode 1 can be automatically triggered, and the fault currents rising rate can be timely controlled. Along with the mode switching, its amplitude can be limited further. In consideration of the SFCLs effects on the induced overvoltage, the qualitative analysis is presented.

In order to calculate the overvoltages induced in the other two phases (phase B and phase C), the symmetrical component method and complex sequence networks can be used. Further, the amplitudes of the B-phase and C-phase overvoltages can be described as.

where UAN is the phase-to-ground voltages root mean square (RMS) under normal condition

It signifies the relationship between the reactance ratio  $m$  and the B-phase overvoltage. It should be pointed out that, for the distribution system with isolated neutral-point, the reactance ratio  $m$

is usually larger than four. Compared with the condition without SFCL, the introduction of the active SFCL will increase the power distribution networks positive-sequence reactance under fault state. Since  $X_0/(X_1 + Z_{SFCL}) < X_0/X_1$ , installing the active SFCL can help to reduce the ratio  $m$ . And then, from the point of the view of applying this suggested device, it can lower the overvoltages amplitude and improve the systems safety and reliability.

Furthermore, taking into account the changes in the locations of the DG units connected into the distribution system, the DG units injection capacities and the fault positions, the specific effects of the SFCL on the fault current and overvoltage may be different, and they are all imitated in the simulation analysis.

### 3 SIMULATION ANALYSIS

For purpose of quantitatively evaluating the current-limiting and overvoltage-suppressing characteristics of the active SFCL, the distribution system with DG units and the SFCL, as shown in Fig. 2 is created in MATLAB. The SFCL is installed in the behind of the power supply  $U_s$ , and two DG units are included in the system, and one of them is fixedly installed in the Bus B (named as DG1). For the other DG, it can be installed in an arbitrary position among the Buses CE (named as DG2). The models main parameters are shown in Table I. To reduce the converters design capacity [17], making the SFCL switch to the mode 2 after the fault is detected, and the detection method is based on measuring the main currents different components by Fast Fourier Transform (FFT) and harmonic analysis.

#### A. Characteristics of the SFCL

Supposing that the injection capacity of each DG is about 80% of the load capacity (load 1), and the fault location is k1 point (phase-A is shorted), and the fault time is  $t = 0.2$  s, the simulation is done when the DG2 is respectively installed in the Buses C, D, and E, and the three cases are named as case I, II, and III. Fig. 4 shows the SFCLs overvoltage-suppressing characteristics, and the waveforms with and without the SFCL.

During the study of the influence of the DGs injection capacity on the overvoltages amplitude, it is assumed that the adjustable

range of each DG units injection capacity is about 70%–100% of the load capacity (load 1), the two DG units are located in the Buses B and E, and the other fault conditions are unchanged, Table II shows the overvoltages amplitude characteristics under this background. Along with the increase of the DGs injection capacity, the overvoltage will be accordingly rise, and once the injection capacity is equal or greater than 90% of the load capacity, the overvoltage will exceed acceptable limit (1.3 times). Nevertheless, if the active SFCL is put into use, the limit-exceeding problem can be solved effectively

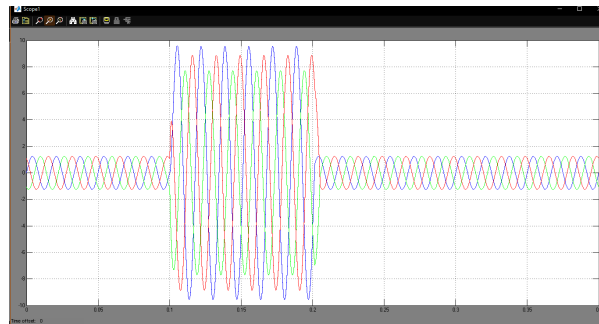

Fig. 2. Line Current During fault conditions.

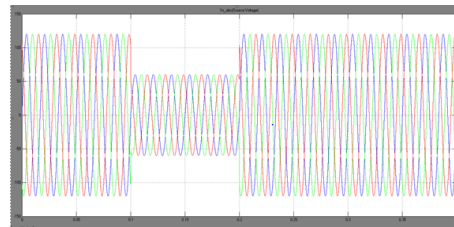

Fig. 3. Line Voltage During fault conditions.

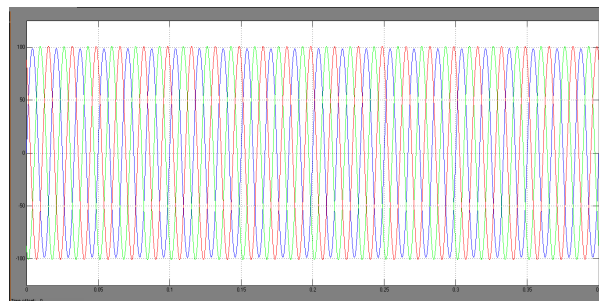

Fig. 4. Load Voltage During fault conditions.

*B. Characteristics of the SFCL with PV:*

By observing the voltage compensation type active SFCLs installation location, it can be found out that this devices current-limiting function should mainly reflect in suppressing the line current through the distribution transformer. There-upon, to estimate the most serious fault characteristics, the following conditions are designed: the injection capacity of each DG is about 100% of the load capacity (load 1), and the two DG units are separately installed in the Buses B and E. Moreover, the three-phase fault occurs at k1, k2, and k3 points respectively, and the fault occurring time is  $t = 0.2$  s. Hereby, the line current characteristics are imitated.

As shown in Fig. 5, it indicates the line current waveforms with and without the active SFCL when the three-phase short-circuit occurs at k3 point. After installing the active SFCL, the first peak value of the fault currents ( $i_{Af}, i_{Bf}, i_{Cf}$ ) can be limited to 2.51 kA, 2.69 kA, 1.88 kA, respectively, in contrast with 3.62 kA, 3.81 kA, 2.74 kA under the condition without SFCL. The reduction rate of the expected fault currents will be 30.7%, 29.4%, 31.4%, respectively.

Fig. 6 shows the SFCLs current-limiting performances when the fault location is respectively k1 point and k2 point (selecting the phase-A current for an evaluation). Along with the decrease of the distance between the fault location and the SFCLs installation position, the current-limiting ratio will increase from 12.7% (k1 point) to 21.3% (k2 point).

Besides, as one component of fault current, natural response is an exponential decay DC wave, and its initial value has a direct relationship with fault angle. In other words, corresponding to different initial fault angles, the short-circuit currents peak amplitudes will be distinguishing Through the application



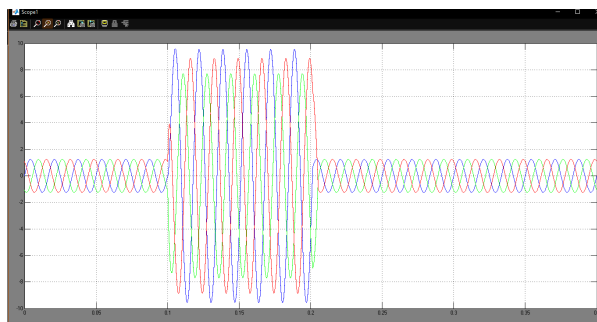

Fig. 5. Line Current During fault conditions

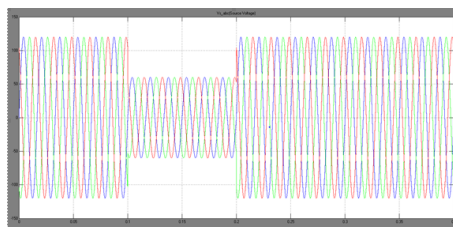

Fig. 6. Line Voltage During fault conditions.

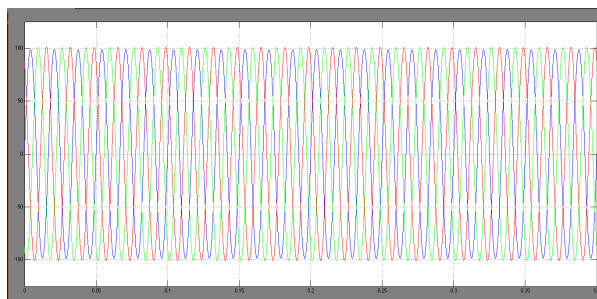

Fig. 7. Load Voltage During fault conditions.

## 4 CONCLUSION

In this paper, the application of the PV based SFCL into in a power distribution network with DG units is investigated. For the power frequency overvoltage caused by a single-phase grounded fault, the PV based SFCL can help to reduce the over- voltages amplitude and avoid damaging the relevant distribution equipment. The active PV

based SFCL can as well suppress the short-circuit current induced by a three-phase grounded fault effectively, and the power systems safety and reliability can be improved. Moreover, along with the decrease of the distance between the fault location and the PV based SFCLs installation position, the current-limiting performance will increase.

## References

- [1] A. Sannino, Global power systems for sustainable development, in IEEE General Meeting, Denver, CO, Jun. 2004.
- [2] K. S. Hook, Y. Liu, and S. Atcitty, Mitigation of the wind generation integration related power quality issues by energy storage, EPQU J., vol. XII, no. 2, 2006.
- [3] R. Billinton and Y. Gao, Energy conversion system models for adequacy assessment of generating systems incorporating wind energy, IEEE Trans. on E. Conv., vol. 23, no. 1, pp. 163169, 2008, Multistate.
- [4] Karen L. Butler, Mehrdad Ehsani, Preyas Kamath, Matlab-Based Modeling and Simulation Package for Electric and Hybrid Electric Vehicle Design, published in IEEE transactions on vehicular technology, vol. 48, no. 6, pp. 1770-1778, November 1999.
- [5] S. W. Mohod and M. V. Aware, A STATCOM-Control Scheme for Grid Connected Wind Energy System for Power Quality Improvement, Published in. Systems Journal, IEEE (Volume:4 , Issue: 3 ), pp. 346-352, sept 2010.
- [6] Chen, Min, and G. A. Rincon-Mora. 2006. Accurate electrical battery model capable of predicting runtime and I-V performance. IEEE Transactions on Energy Conversion 21 (2):504-511.
- [7] Schweighofer, B., K. M. Raab, and G. Brasseur. 2003. Modeling of high power automotive batteries by the use of an automated test system. IEEE Transactions on Instrumentation and Measurement 52 (4):1087-1091.

- [8] Tremblay, O, Dessaint, L.-A. "Experimental Validation of a Battery Dynamic Model for EV Applications." World Electric Vehicle Journal. Vol. 3 - ISSN 2032-6653 - 2009 AVERE, EVS24 Stavanger, Norway, May 13 - 16, 2009.
- [9] T. Kinjo and T. Senjyu, Output leveling of renewable energy by electric double layer capacitor applied for energy storage system, IEEE Trans. Energy Conv., vol. 21, no. 1, Mar. 2006.
- [10] R. S. Bhatia, S. P. Jain, D. K. Jain, and B. Singh, Battery energy storage system for power conditioning of renewable energy sources, in Proc. Int. Conf. Power Electron Drives System, Jan. 2006, vol. 1, pp.501506.
- [11] Fu. S. Pai and S.-I. Hung, Design and operation of power converter for microturbine powered distributed generator with capacity expansion capability, IEEE Trans. Energy Conv., vol. 3, no. 1, pp. 110116, Mar.2008.
- [12] J. Zeng, C. Yu, Q. Qi, and Z. Yan, A novel hysteresis current control for active power filter with constant frequency, Elect. Power Syst. Res., vol. 68, pp. 7582, 2004.
- [13] M. I. Milands, E. R. Cadavai, and F. B. Gonzalez, Comparison of control strategies for shunt active power filters in three phase four wire system, IEEE Trans. Power Electron., vol. 22, no. 1, pp. 229236, Jan.2007.
- [14] S. W. Mohod and M. V. Aware, Power quality issues & its mitigation technique in wind energy conversion, in Proc. of IEEE Int. Conf. Quality Power & Harmonic, Wollongong, Australia, 2008.